

Micronics U1000-HM

Clamp On Ultrasonic Heat Meter

User Manual



Micronics Ltd, Knaves Beech Business Centre, Davies Way, Loudwater,
High Wycombe, Bucks HP10 9QR

Table of Contents

1	General Description	3
2	Quick start procedure	4
3	How does it work?	5
4	User interface	6
4.1	Key switches	6
5	Installing the U1000-HM.....	7
5.1	Preparation.....	8
5.2	Sensor separation	8
5.3	Attaching the U1000-HM to the pipe	10
5.4	Adaptors for small pipes.....	11
5.5	Attaching the Temperature sensors	12
5.6	U1000-HM interface cable	13
5.7	Connecting the U1000-HM to the Supply	13
5.8	Pulse Output connection	13
5.9	Modbus connections (Optional)	13
5.10	Cable Screen.....	14
6	Powering up for the first time	14
6.1	How to enter the Pipe ID	15
6.2	Pulse output	16
6.2.1	Volumetric mode	16
6.2.2	Frequency mode	16
6.2.3	Energy	16
6.2.4	Low Flow Alarm.....	16
6.3	Modbus (Optional).....	16
7	Subsequent Power-ON Sequence	17
7.1	Information screens.....	18
8	Password Controlled Menus	19
8.1	General procedure for changing menu settings.....	19
8.1.1	Selection menus.....	19
8.1.2	Data entry menus	19
8.2	User Password controlled menu structure	19
9	Diagnostics Menu.....	24
10	Relocation of guide rail.....	25
11	Appendix I – U1000-HM Specification	26
12	Appendix II – Default values	27
13	Appendix III – Error and Warning Messages	28
14	Declaration of conformity	29

1 General Description

- Fixed installation, clamp-on heat meter
- Easy to install
- Requires the minimum of information to be entered by the user
- Transducer separation distance is factory preset to a nominal pipe size
- Electronics and guide rail housings form an integral unit
- Attached to the pipe using the supplied jubilee clips
- Power to the unit is provided by an external 12 - 24V ac/dc power supply
- Operates on steel, copper and plastic pipes with ID's in the range 20mm (0.8") to 110mm (4") and a maximum wall thickness limit of 9mm for metal pipes and 10.5mm for plastic.
- Simple to install temperature sensors
- Compact, rugged and reliable, the U1000-HM has been designed to provide sustained performance in industrial environments

U1000 standard features include:

- 2 line x 16 character LCD with backlight
- 4-key keypad
- Isolated pulse output
- Simplified factory configured guide rail and transducer assembly
- Dual PT type temperature sensors (standard cable length 5m)
- Continuous signal monitoring
- Password protected menu operation for secure use
- Operates from external 12 to 24Vac or dc power supplies
- Small pipe adaptors

Optional features

- Modbus RTU data output

Typical applications

- Domestic, building services and industrial water systems heat meter.

2 Quick start procedure

The following procedure details the steps required to set up the heat meter. See the sections referred to if you are unsure about how to install the instrument.

1. Establish a suitable location for the flow meter on a straight length of pipe clear of bends and valves or similar obstructions.(See Sections 5 and 5.1)
2. Determine the pipe internal diameter and material.
3. Either use the table in the manual, or power up the instrument to determine the correct separation code. (See Sections 5.2 or 6)
4. Set the sensors to the correct separation by adjusting the sensor holding screws so the sensor can slide in the slot. (See Section 5.2)
5. Select any adaptors needed for pipes with an **outside** diameter of less than 60mm, **inside** diameter will typically be less than 50mm. (See Section 5.4)
6. Grease the sensors and mount the guide rail on the pipe using the banding provided, then remove the sensor holding screws. (See Section 5.3)
7. Wire the electronics up to a 12 to 24V ac or dc power supply via the Blue and Brown wires. (See Section 5.7)
8. Plug in the temperature sensors and place them touching each other. Wait for the temperature readings to stabilize, indicated by no change for 30 seconds. Then zero the temperature sensors. (See Section 5.5)
9. Attach the temperature sensors on to the pipe using the self-adhesive pads. Then use the supplied banding to secure the sensor to the pipe. Don't overtighten the banding. The sensor must be in good thermal contact with the pipe and the leads must not be under any strain. (See Section 5.5)
10. Plug in the flow sensors and clip the electronics assembly on to the guide rail.
11. Power up the instrument and check that flow and temperature readings can be obtained(See Sections 6 and 7.1)
12. Once good readings have been obtained any further changes, such as selecting different units, can be made via the User Menu. (See Section 8)
13. If the Modbus output is being used then the address of the instrument must be set using the User Menu. (See Section 8) The default address is 1 and the Baud rate is set to 38400, slower Baud rates can be set.

3 How does it work?

The U1000-HM is a clamp-on, ultrasonic flowmeter that uses a multiple slope transit time algorithm to provide accurate flow measurements.

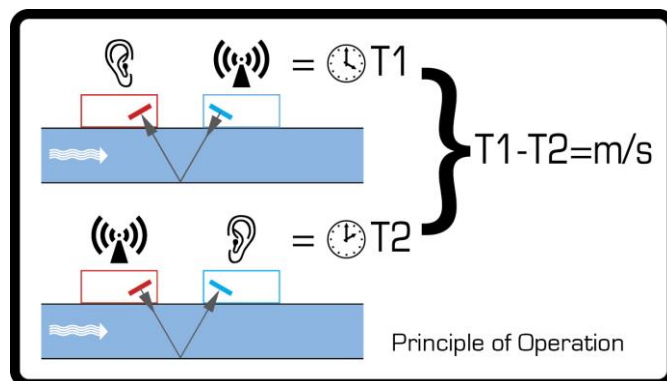

Figure 1 Principle of Transit-Time operation

An ultrasonic beam of a given frequency is generated by applying a repetitive voltage pulse to the transducer crystals. This transmission goes first from the Downstream transducer to the Upstream transducer (red) as shown in the upper half of Figure 1. The transmission is then made in the reverse direction, being sent from the Upstream transducer (red) to the Downstream transducer (blue) as shown in the lower half of Figure 1. The speed at which the ultrasound is transmitted through the liquid is accelerated slightly by the velocity of the liquid through the pipe. The subsequent time difference $T1 - T2$ is directly proportional to the liquid flow velocity.

The two temperature sensors measure the difference in temperature between inlet and outlet of the flow system being monitored. The temperature difference, in combination with the volume of water that has flowed through the system, is then used to calculate the energy transferred to or from the water.

4 User interface

Figure 2 illustrates the U1000-HM user interface comprising:-

- One 2 line x 16 character LCD with backlight
- Four tactile key switches
- Two LED's
-



Figure 2 U1000-HM User Interface

4.1 Key switches

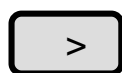

Selection key. Allows the user to select between options on the display.



Used to decrement the value of each digit in numeric entry fields.



Used to increment the value of each digit in numeric entry fields.



Used to enter the selection displayed or terminate the data entry. Pressing this key can also take the user to a sub menu or to the Flow Reading screen.



kWh LED, this pulses each time an energy pulse is sent by the instrument.



Pulse Enabled LED is illuminated when the Pulse output is ON.

5 Installing the U1000-HM

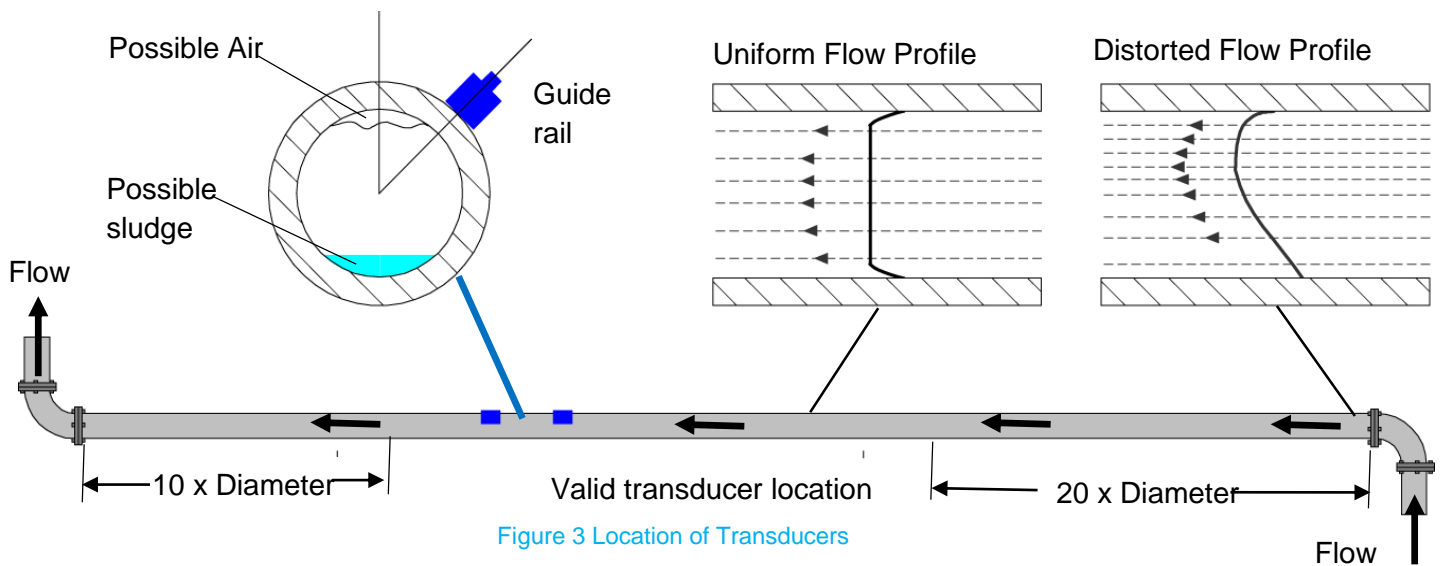

Figure 3 Location of Transducers

For correct measurement of the energy transfer being measured by the instrument the flow measurement needs to be made on the hot side of the system as near the hot temperature sensor as possible.

In many applications an even flow velocity profile over a full 360° is unattainable due, for example, to the presence of air turbulence at the top of the flow and possibly sludge at the bottom of the pipe. Experience has shown that the most consistently accurate results are achieved when the transducer guide rails are mounted at 45° with respect to the top of the pipe.

The U1000-HM equipment expects a uniform flow profile, as a distorted flow will produce unpredictable measurement errors. Flow profile distortions can result from upstream disturbance such as bends, tees, valves, pumps and other similar obstructions. To ensure a uniform profile the transducers must be mounted far enough away from any cause of distortion such that it no longer has an effect.

To obtain the most accurate results the condition of both the liquid and the pipe must be suitable to allow ultrasound transmission along the predetermined path. It is important that liquid flows uniformly within the length of pipe being monitored, and that the flow profile is not distorted by any upstream or downstream obstructions. This is best achieved by ensuring there is a straight length of pipe upstream of the transducers of at least 20 times the pipe diameter, and 10 times the pipe diameter on the downstream side, as shown in Figure 3. Flow Measurements can be made on shorter lengths of straight pipe, down to 10 diameters upstream and 5 diameters downstream, but when the transducers are mounted this close to any obstruction the resulting errors can be unpredictable.

Key Point: Do not expect to obtain accurate results if the transducers are positioned close to any obstruction that distorts the uniformity of the flow profile.

Micronics Ltd accepts no responsibility or liability if product has not been installed in accordance with the installation instructions applicable to the product.

5.1 Preparation

1. Before attaching the transducers first ensure that the proposed location satisfies the distance requirements shown in [Figure 3](#) otherwise the resulting accuracy of the flow readings may be affected.
2. Prepare the pipe by degreasing it and removing any loose material or flaking paint in order to obtain the best possible surface. A smooth contact between pipe surface and the face of the transducers is an important factor in achieving a good ultrasound signal strength and therefore maximum accuracy.

5.2 Sensor separation

The sensor must be positioned at the correct distance for the pipe size and type they will be used on. The table below gives the typical separation code for a given pipe material and Inside diameter, based on a 4mm wall thickness. If the wall thickness is significantly different from this value then the separation may need to be one code higher or lower. The instrument displays the required separation after the pipe internal diameter and material are entered.

Pipe ID range

Separation	Pipe material	
	Plastic and Copper	Steel
B1	20-24	---
A2	25-30	20-22
C1	31-36	23-28
B2	37-42	29-34
A3	43-48	35-40
C2	49-54	41-46
B3	55-60	47-52
D2	61-65	53-58
C3	66-71	59-64
B4	72-77	65-70
D3	78-83	71-76
C4	84-89	77-82
E3	90-95	83-88
D4	96-101	89-94
F3	102-107	95-100
E4	108-110	101-106
D5	---	107-110

Figure 4 Separation Table

The diagram below shows how to adjust the separation of the sensors

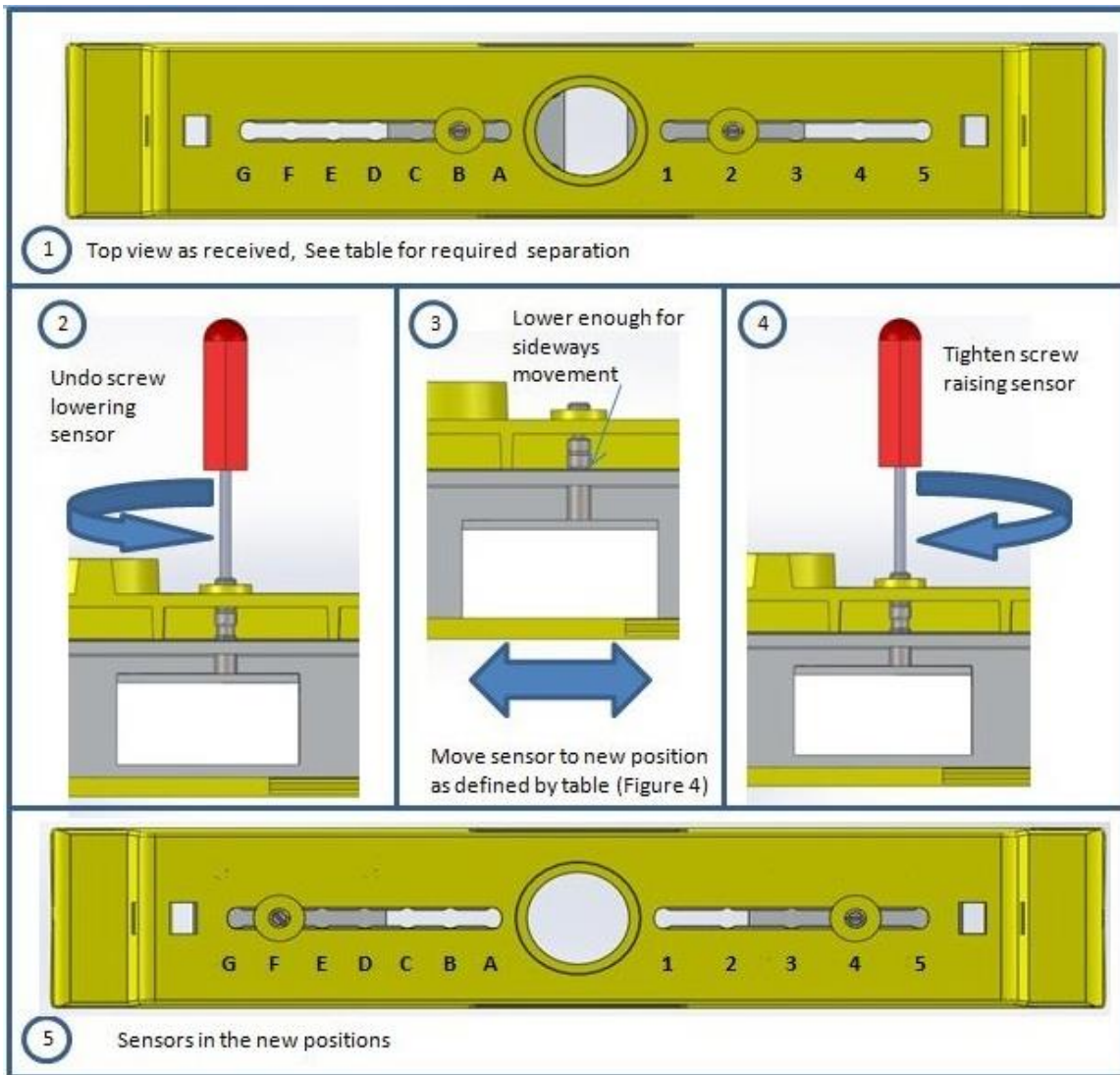
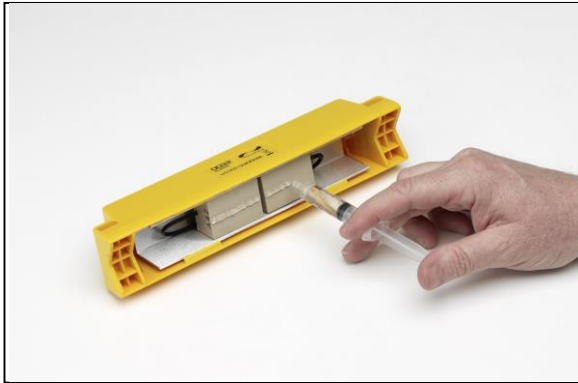

Figure 5 Separation Setting

5.3 Attaching the U1000-HM to the pipe

Follow the five steps shown in Figure 6 below to attach the U1000-HM to the pipe.



The grease provided in the syringe is applied to the centre of the sensors as shown above.



Clamp guide rail and sensor assembly to pipe, using the supplied banding, and release sensor locking screws.



Connect power and sensors to the electronics assembly. Sensor leads can be connected either way round.



Click electronic assembly onto guide rails and sensor assembly

Figure 6 simple steps to attaching the U1000-HM on the pipe

The locking screws and washers should be kept in case it is necessary to change the location of the guide rail and sensors. See the relocation section for the procedure to do this.

5.4 Adaptors for small pipes

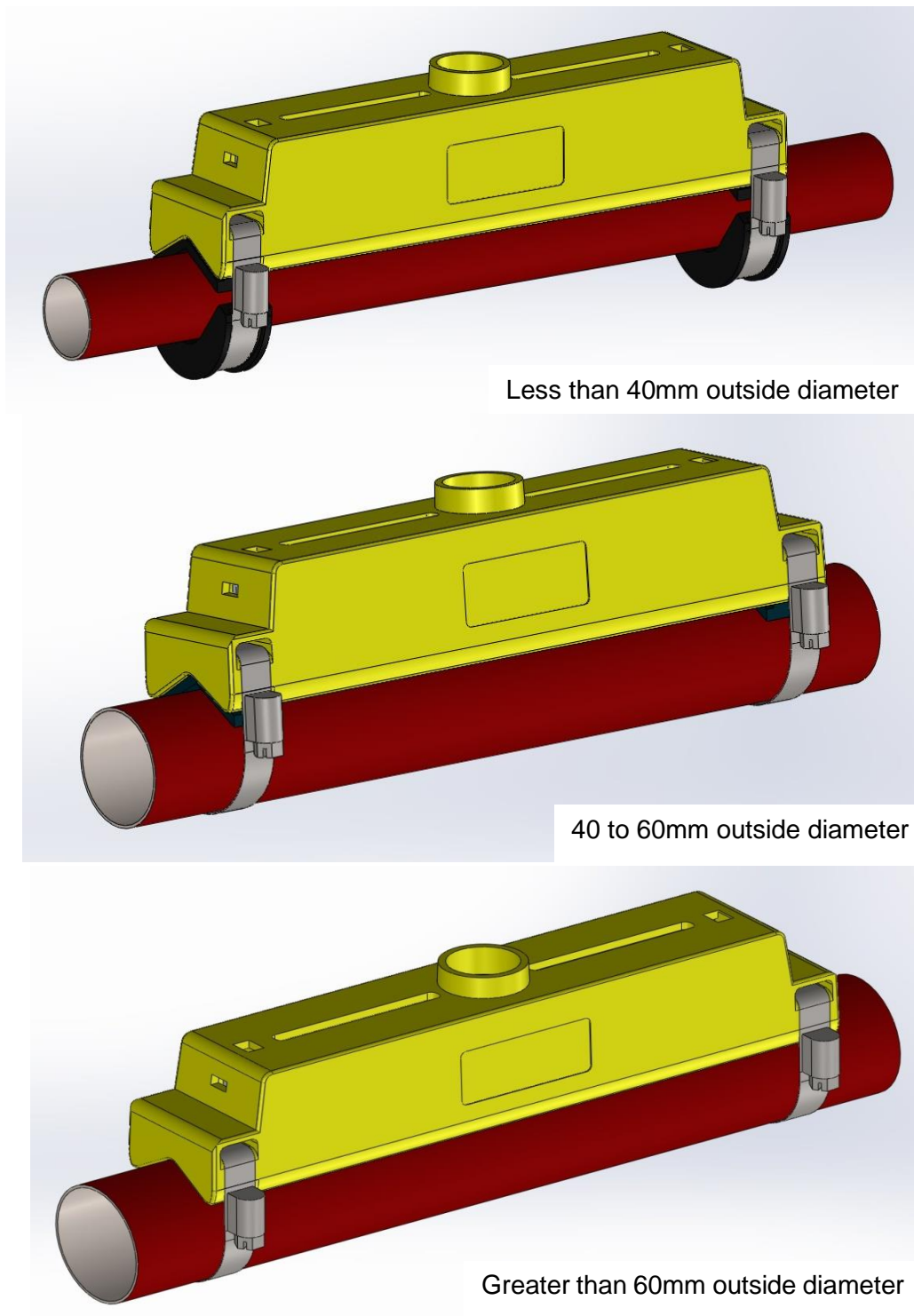

Figure 7 Pipe Adaptors

Guide rails for small pipes are supplied with adaptors. The diagrams above shows how these are fitted around the pipe. The top pipe adaptor clips into the ends of the guide rail.

5.5 Attaching the Temperature sensors

The temperature sensors must be located at the input and output of the system that is being monitored. The area of pipe where they are to be attached must be free of grease and any insulating material. It is recommended that any coating on the pipe is removed so that the sensor has the best possible thermal contact with the pipe.

The sockets on the enclosure are marked Hot and Cold. This defines the location of the temperature sensors on installations where heat is being extracted from the system.

To ensure an accurate temperature differential the following procedure should be used.

1. Plug in the sensors and place them touching each other.
2. Switch on the instrument and leave running for about 30 minutes.
3. Enter the password controlled menu (See Section 8) and scroll to the calibration sub menu.
4. Press the enter key until the Zero Temp Offset screen is displayed.
5. Select Yes and press the Enter key to display the Attach Sensors screen.
6. Press the Enter key again and wait for instrument to return to the Zero Temp Offset screen.

The instrument can now be turned off and the installation of the temperature sensors completed.

The sensors have self-adhesive pads to locate them, they are then anchored using similar banding to that used to mount the flow transducers. The banding must not be over tightened or the sensors **will be damaged**. If the sensors are located under pipe lagging then ensure this does not put a strain on the sensor cables. Tie down the sensor cables after the sensor has been installed.

The temperature sensors must be used with the cable length supplied. Extending or shortening the cables will negate the calibration of the sensors.

5.6 U1000-HM interface cable

The U1000-HM interface cable supplied is a 6-core cable and is shown in Figure 8.

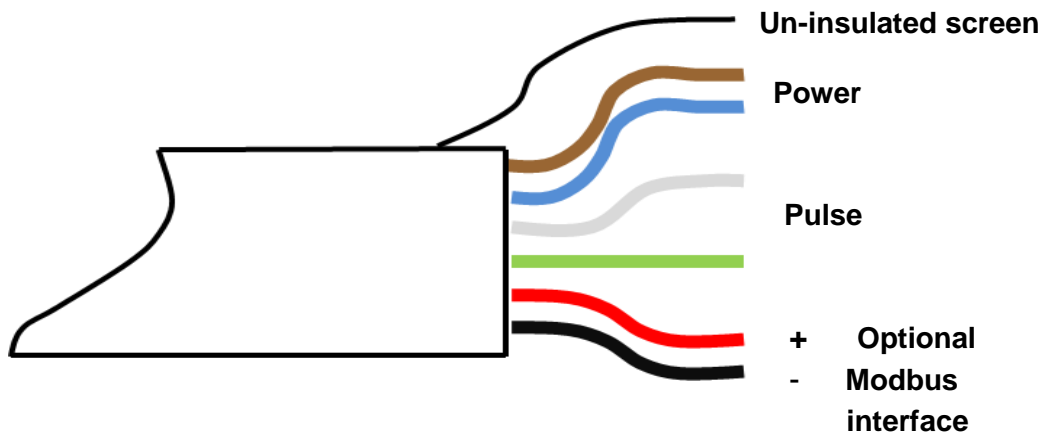





Figure 8. U1000-HM Interface Cable

The polarity of the wires is as follows:

	12/24V Input
	12/24V Return
	Pulse Output
	Pulse Return

The un-insulated wire is the connection to the screen of the cable and should be earthed for full immunity to electrical noise.

5.7 Connecting the U1000-HM to the Supply

The U1000-HM will operate within the voltage range 12 - 24V ac/dc. Connect the external power supply to the Brown and Blue wires of the six core cable. For full compliance with EMC regulation a 12V supply is recommended for domestic and light industrial applications.

5.8 Pulse Output connection

The isolated pulse output is provided by a SPNO MOSFET Relay which has a maximum load current of 500mA and maximum load voltage of 48V AC. The relay also provides 2500V isolation.

The pulse output is available at the White and Green wires. Electrically this is a volt free contact closure.

5.9 Modbus connections (Optional)

The Red and Black wires provide an optional Modbus interface over a twisted pair cable. The physical connection is RS485.

5.10 Cable Screen

For full immunity to electrical interference the screen of the cable should be connected to Earth.

6 Powering up for the first time

Powering up for the first time will initiate the sequence shown in Figure 9:

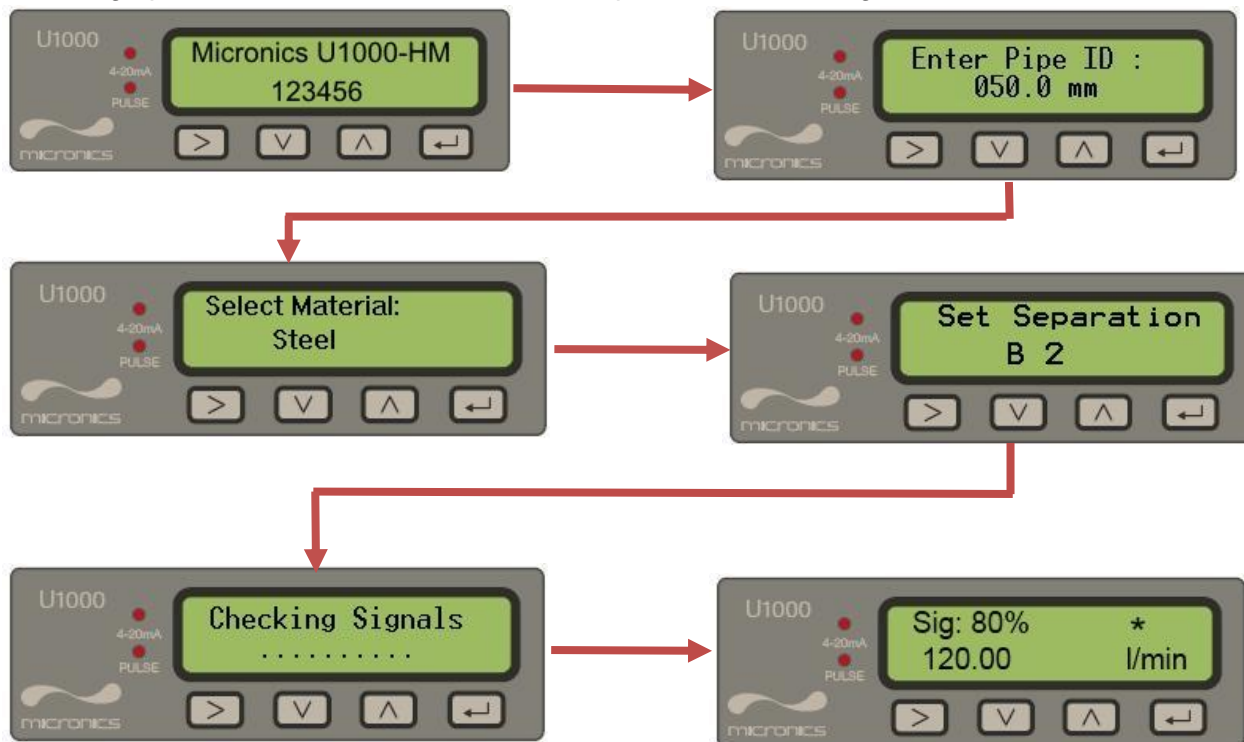

Figure 9 initial power up screens

1. The Micronics start up screen is displayed for 5 seconds
2. The user enters the pipe ID and selects the material (refer to section 6.1)
3. On pressing enter in response to the Set Separation screen the U1000-HM then checks for a valid signal.
4. If a valid signal is found, signal strength and flow magnitude are displayed. The signal strength should be at least 40% for reliable operation. The direction of flow when powered up will be set as that for positive flow. The pulse output will relate to the flow in this direction. If the flow is reversed then the flow rate will still be displayed but the activity indication will change from an asterisk to an exclamation mark and no pulses will be generated. If a valid flow reading is obtained then after a few seconds the Total Energy screen will be displayed.

If the flow value is displayed as "-----" this indicates that there is no usable signal from sensors.

The cause of this could be incorrect pipe data, no grease on the sensors, sensor not in contact with the pipe or very poor surface conditions on the inside of the pipe.

6.1 How to enter the Pipe ID

Figure 10 shows the Enter Pipe ID screen after an initial power up.







Figure 10 Enter Pipe ID Screen (Metric)

Initially, the hundreds unit (050.0) will blink.

Press the  key to increment the hundreds digit (050.0) in the sequence 0, 1. Press once to increment digit, or hold key down to automatically toggle between 0 and 1.

Press the  key to decrement the hundreds digit in the sequence 1, 0. Press once to decrement digit, or hold key down to automatically toggle between 1 and 0.



Press the  key to move to the tens digit (050.0). The tens digit should now blink. Increment the tens digit in the sequence 0,1,2,3,4,5,6,7,8,9,0 using the  key. Press once to increment digit or hold down to scroll through the numeric sequence. Decrement the tens digit in the sequence 9,8,7,6,5,4,3,2,1,0,9 using the  key. Press once to increment digit or hold down to scroll through the numeric sequence.

Press the  key to move to the units digit (050.0). The units digit should now blink. Increment or decrement the units digit in an identical manner to the tens digit described above.

Press the  key to move to the decimal digit (050.0). The decimal digit should now blink. Increment or decrement the decimal digit in an identical manner to the tens digit described above.

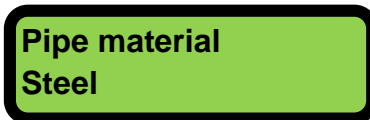
Press the  key to enter the Pipe ID numerical value, and move to the next screen

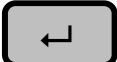

Use  and  keys to scroll through the pipe materials and then press

 To select the material and complete the setup procedure.

If any of the parameters need to be changed from the default values, for example different units are required, then the menu system must be activated via the password (see section 8).

6.2 Pulse output

Pulse output can be set up to operate in four modes, namely volumetric, frequency, energy or Low Flow Alarm.

6.2.1 Volumetric mode

In Volumetric mode, each pulse output represents a measured volume of 10 litres (default value). In Volumetric mode, with the Vol per Pulse set to 1 and the pulse width set to 25ms, the maximum number of pulses that can be output (without storage) is $1/(0.025*2) = 20$ pulses per second. If the flow rate in the pipe is such that more than 20 pulses per second are generated, a Pulse Overflow error may eventually occur if the stored number of pulses exceeds 1000. To avoid this, set the Vol per Pulse to 10 litres, or reduce the Pulse Width value.

6.2.2 Frequency mode

In Frequency mode, the pulse output frequency is proportional to the flow rate within a specified frequency range of 0 – 200Hz. The flow units on the frequency output are fixed as litres per second.

6.2.3 Energy

In Energy mode, each pulse represents an amount of energy e.g. 1kWh. The same limitation on maximum pulse rate applies as detailed in the Volumetric Mode. Again a larger unit of energy per pulse or a smaller pulse width may be required.

6.2.4 Low Flow Alarm

This mode will turn on the pulse output (low resistance path) when the flow rate goes below the value set in the parameters for this mode. There is a 10% hysteresis on the switching of the output. Once turned on the flow rate must rise by 10% more than the set value to turn it off again.

6.3 Modbus (Optional)

The Modbus RTU interface is configured via the Modbus sub menu in the password controlled menu.

The Baud rate can be selected in the range 1200 to 38400.

The address can be set in the range 1 to 254.

The following registers can be read. The instrument responds to the “read holding registers” (CMD 03).

If the flow reading is invalid then the flow value will be zero.

If a temperature sensor goes out of range then the value will go to -11°C.

Both of these faults will clear the status bit.

Modbus Register	U1000 Register	Description	Notes
40001	0	Device ID	0xac for the U1000-HM
40002	1	Status	0= fault, 1= system ok
40003	2	Hot or Cold	0x04 for hot 0x0c for cold
40004	3	Serial number	Integer value
40005	4-5	Firmware rev	Integer value
40007	6-7	Flow m3/sec	2 registers IEEE754 floating Point
40009	8-9	Flow m3/hr	2 registers IEEE754 floating Point
40011	10-11	Power kW	2 registers IEEE754 floating Point
40013	12-13	Energy kWh	2 registers IEEE754 floating Point
40015	14-15	Hot temperature	2 registers IEEE754 floating Point
40017	16-17	Cold temperature	2 registers IEEE754 floating Point
40019	18-19	Delta temp	2 registers IEEE754 floating Point

Figure 11 Modbus registers

7 Subsequent Power-ON Sequence

If the power supply is cycled OFF then ON after the pipe data has been entered, all subsequent start-ups will use the same configuration as was previously entered. If the configuration needs to be changed for any reason, the user can make use of the password-controlled menu as described in section 8.

7.1 Information screens

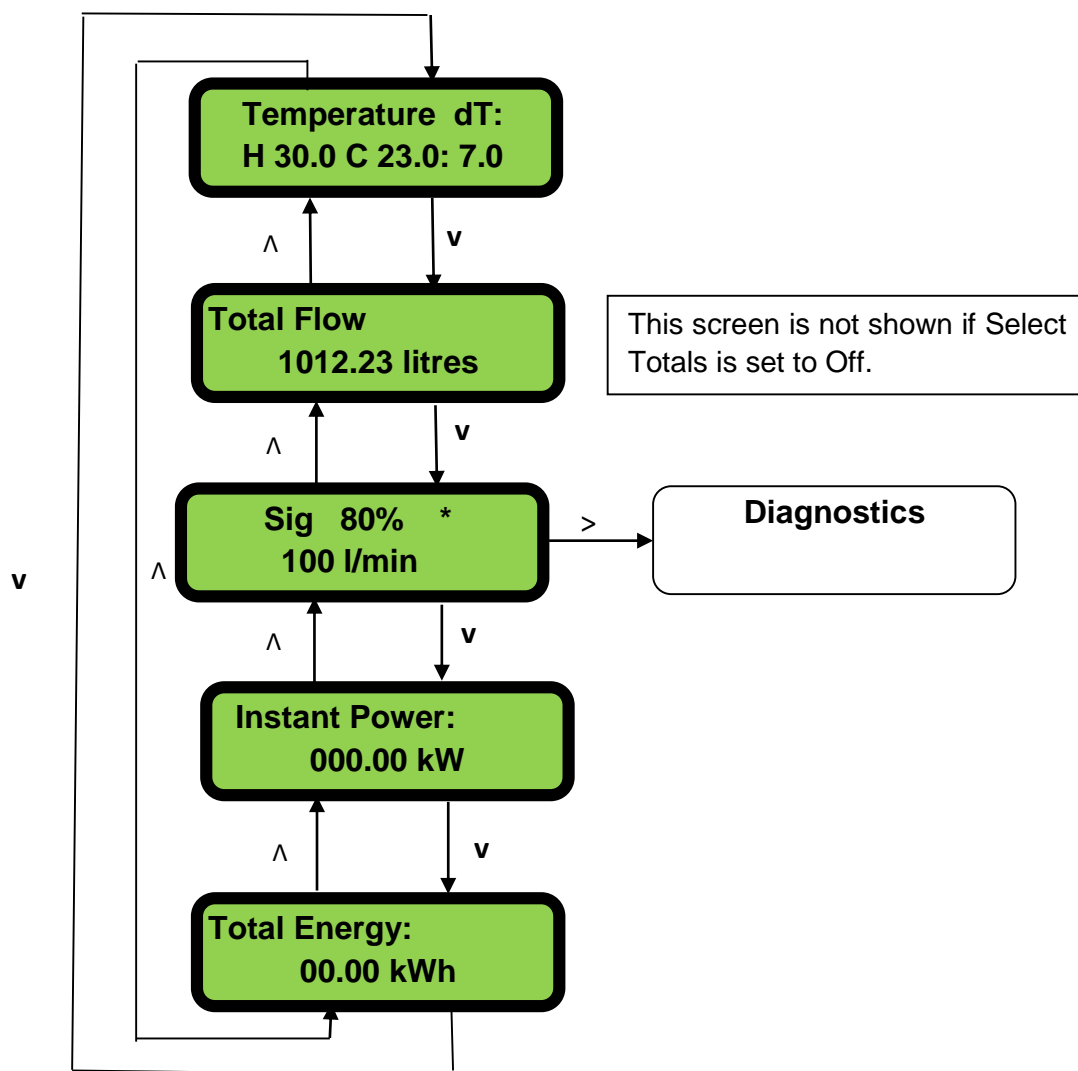

Figure 12 information screens

The system will initially display the Flow Reading screen. If there are valid flow and temperature readings, then after a few seconds the Total Energy screen will be displayed.

If the flow reading is invalid then the Flow screen will be displayed. Similarly the Temperature screen will be displayed if a reading goes out of range.

8 Password Controlled Menus

The password controlled menu allows the user some flexibility to change the default settings:

User Password (71360):

- Change the dimensions from mm to inches or vice-versa.
- Change from Flow to Velocity Measurement
- Change the system units litres/m³ or Impgal/USgal
- Change the flow units l/s, l/min or gal/s, gal/min or USgals/s, USgals/min
- Change the Pulse Output type
- Change the Pulse output parameters
- Change the energy units

8.1 General procedure for changing menu settings

8.1.1 Selection menus

When a password controlled menu is selected the procedure for changing the default setting is the same for all menus. For example, consider the Flow Units menu shown in Figure 13.

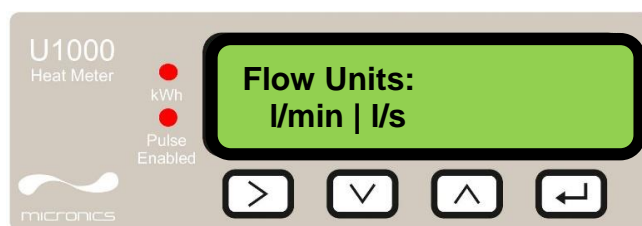





Figure 13 Flow Units menu

The default value 'l/min' will blink to indicate that this is the current setting. To change to 'l/s', press the  key. Now the 'l/s' units will blink to indicate that this is now the selected units. Press the  key to confirm the change.

The only exceptions to this are in the Pulse output menu, where the  and  keys are used to scroll through the options Volume/Frequency/Energy, and the Energy per Pulse values.

8.1.2 Data entry menus

Menus containing a numeric value can be altered using the same method used to input the pipe ID.

8.2 User Password controlled menu structure

While in any of the information screens pressing the  key will access the user password menu. Enter 71360 using the procedure explained in section 6.1 to enter the password.

The flow chart shown in Fig.14 shows the user password menu structure. To skip over any menu item that should remain unchanged, simply press the  key.

71360 MENU

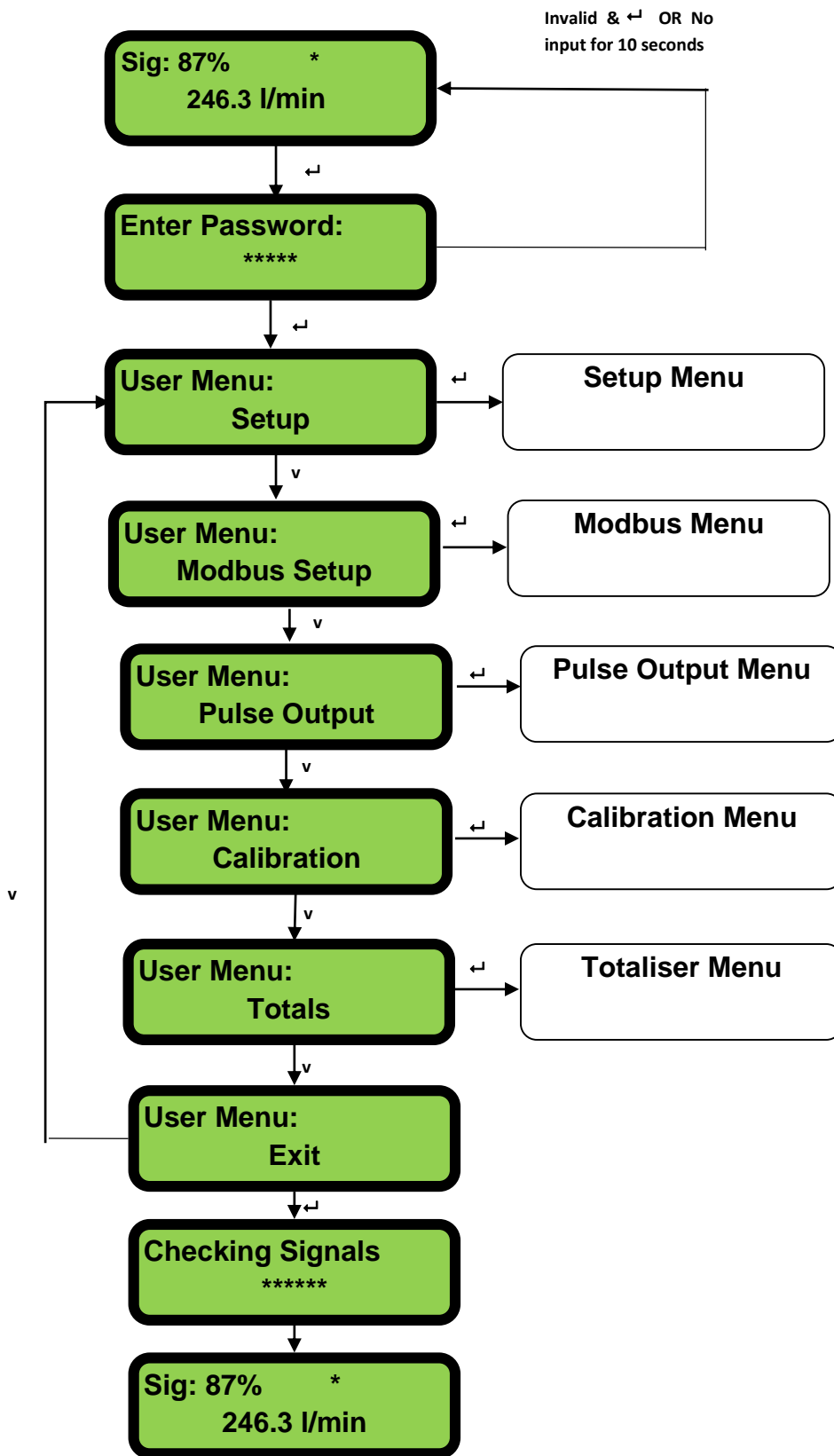

Figure 14 Main Menu

SETUP MENU

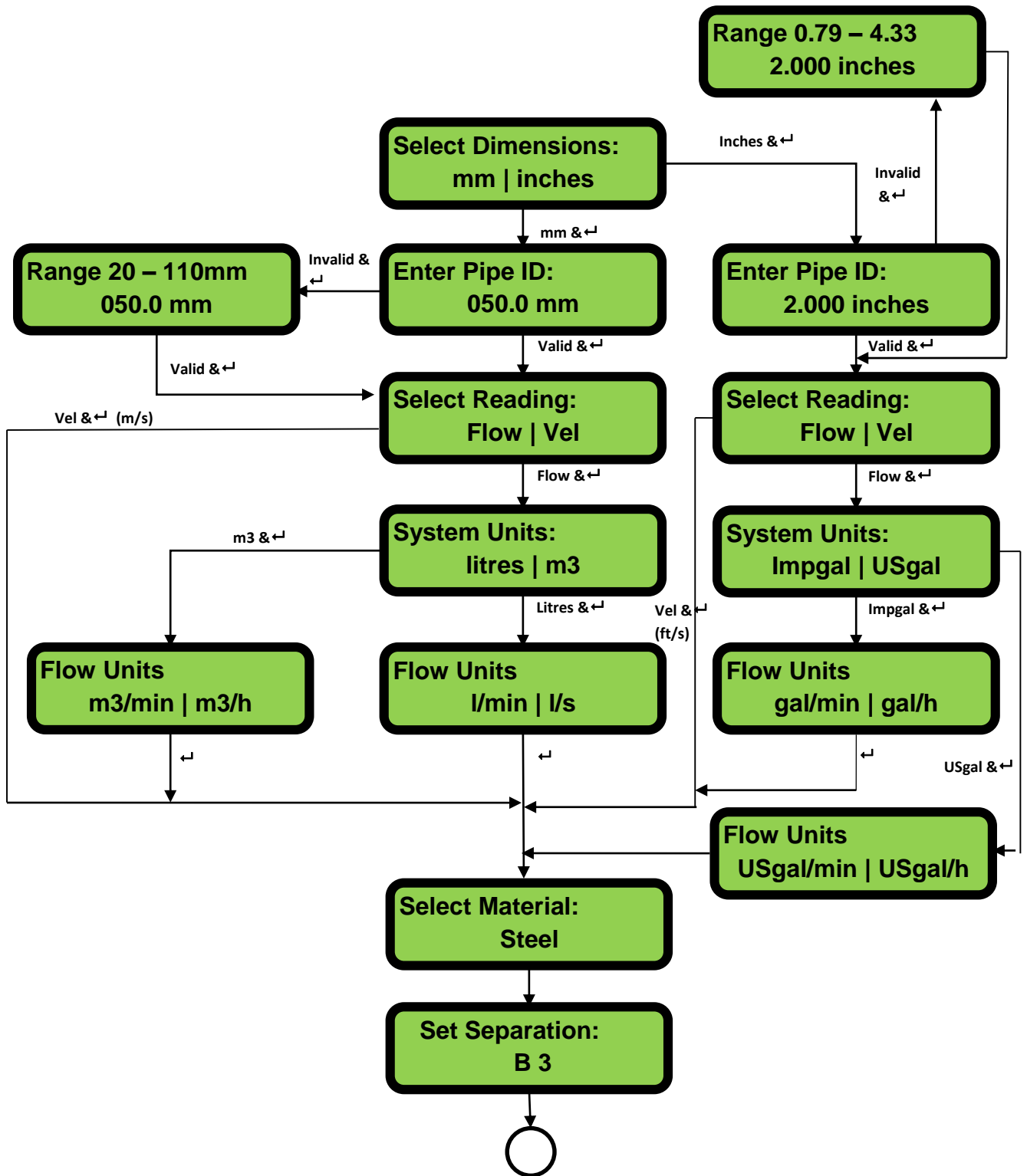
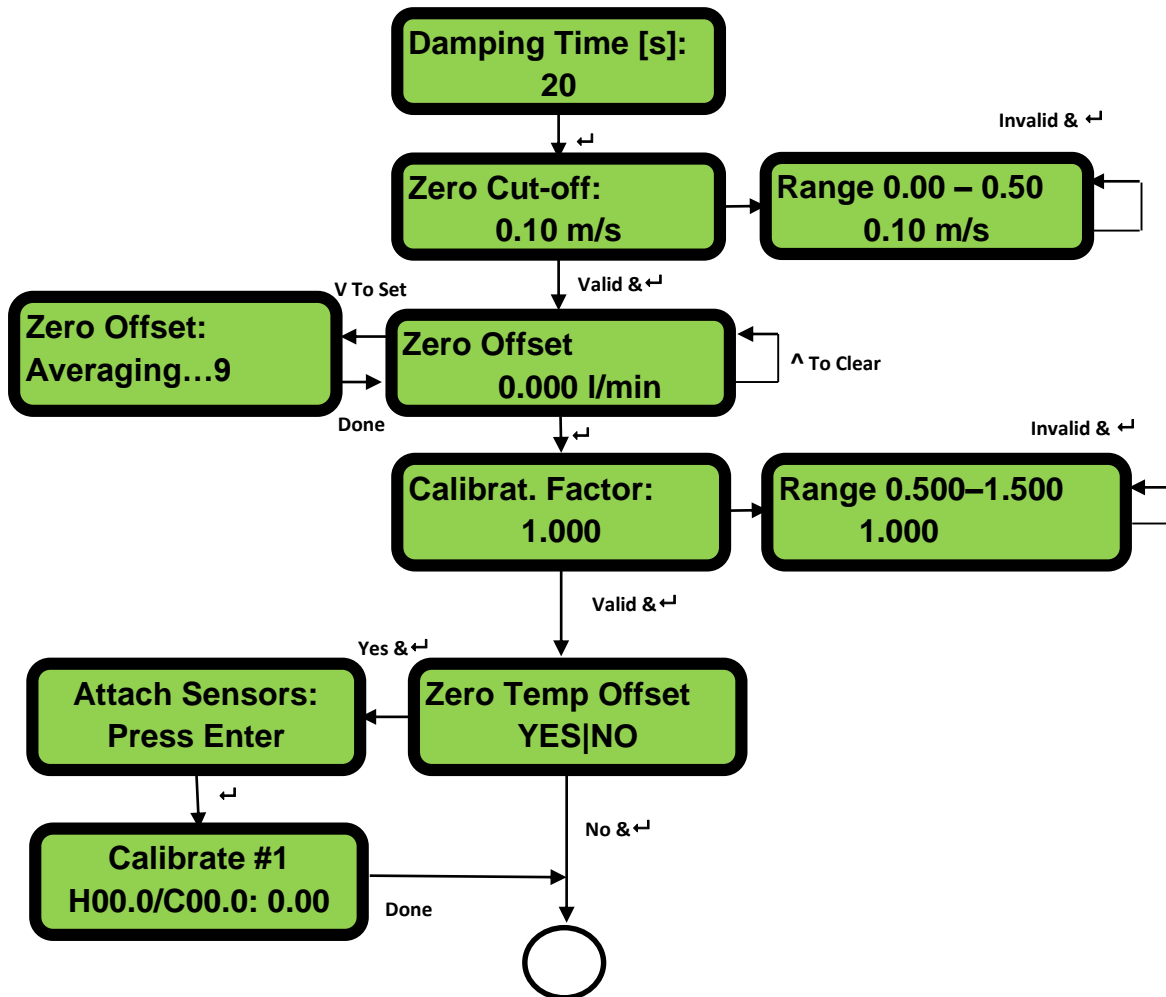

Figure 15 Setup Menu

CALIBRATION MENU



TOTALISER MENU

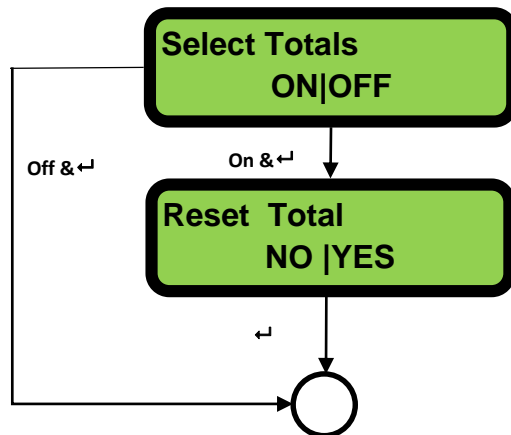



Figure 17 Calibration and totaliser Menu

9 Diagnostics Menu

The diagnostics menu provides some additional information about the heat meter and its setup. The menu can be accessed by pressing the  key from flow reading screen. The menu shown below describes the various diagnostics items.

DIAGNOSTICS MENU

Pres  To exit the Diagnostics

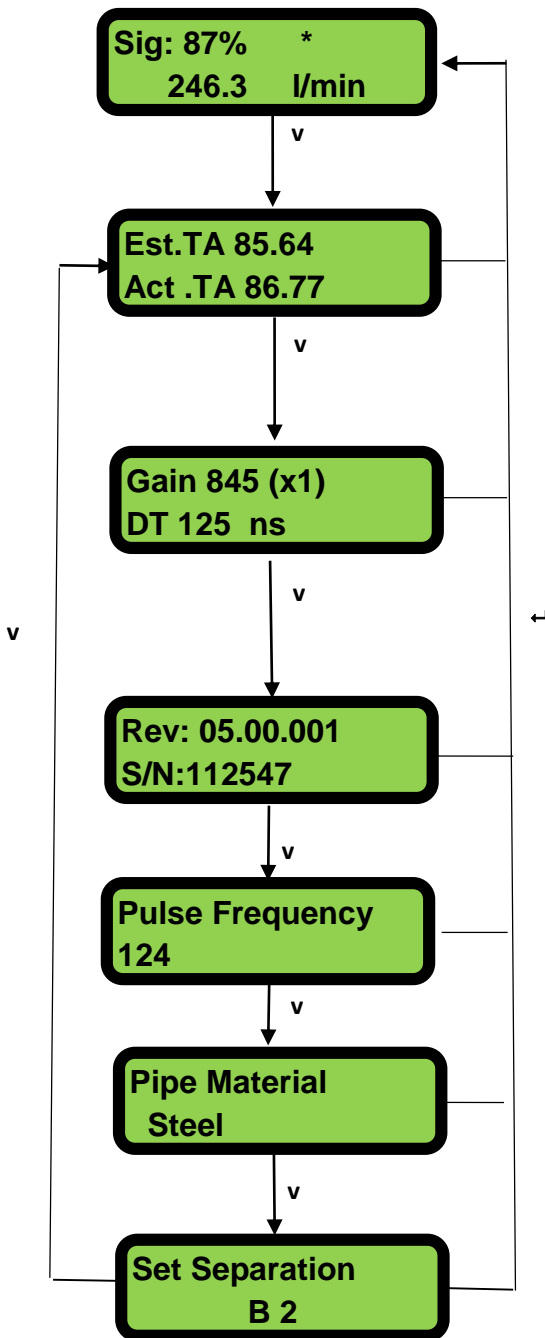

N. B. The key board is less responsive in the Diagnostics Menu and longer key presses are required.

The Estimated TA (Time of Arrival) and Actual TA show the theoretical and measured transit times. These values should be within several per cent of each other. If the actual value is displayed as 9999.99 then a usable signal could not be detected.

The gain on line one is an indicator of the signal strength. A good signal should have a gain of between 600 to 970. The number in parentheses is the switch setting and should be x1 or x10. Gains of X100 show that the received signal is too small to be used.

The second line shows the current time differential between the upstream and downstream signals.

The unit's software version is shown on line 1. Line 2 shows the unit's serial number.

This screen will be displayed if the Pulse output is on, and show data related to the mode of operation. This includes a live display of the Frequency output

The Selected pipe material

The required sensor separation

Figure 18 Diagnostics Menu

10 Relocation of guide rail

If it is necessary to relocate the guide rail and sensor assembly use the following procedure.

1. Remove complete assembly from the pipe.
2. Insert a small screwdriver in the hole at the end of the guide rail moulding and lever up the clip holding the electronics assembly by pressing down on the screwdriver as shown below.
3. Repeat 2 on the other end and then pull off the electronics unit.

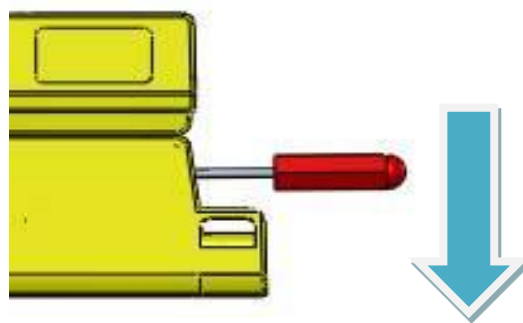

Figure 19

4. Disconnect the sensors
5. Remove the original grease from the sensors
6. Push the sensor blocks into the guide rail so that the washers and locking screws can be refitted.
7. Place a bead of grease down the centre of the sensor block using the syringe provided. See illustration on fitting the guide rail to the pipe for recommended bead size.
8. Follow the original procedure for installing the guide rail on the pipe.

11 Appendix I – U1000-HM Specification

Table 1 lists the U1000-HM Product Specification.

General	
Measuring Technique	Transit time
Measurement channels	1
Timing Resolution	±50ps
Turn down ratio	200:1
Flow velocity range	0.1 to 10m/s bidirectional
Applicable Fluid types	Clean water with < 3% by volume of particulate content.
Accuracy	±3% of flow reading for flow rate >0.3m/s
Repeatability	±0.5% of measured value
Selectable units	Velocity: m/s, ft/s Flow Rate: l/s, l/min, gal/s, gal/min, USgal/s, USgal/min, m ³ /min, m ³ /h Volume: litres, m ³ , gals, USgals Energy : kWh, MWh
Totaliser	8 digits with roll over to zero
Languages supported	English only
Power input	12 – 24V ac or dc
Power consumption	7VA maximum
Cable	5m screened 6 core
Pulse Output	
Output	Opto-isolated MOSFET volt free normally open contact.
Isolation	2500V
Pulse width	Default value 25ms; programmable range 3 – 99ms
Pulse repetition rate	Up to 166 pulses/sec (depending on pulse width)
Frequency mode	200 Hz maximum
Maximum load voltage/current	48V AC / 500mA
Temperature sensors	
Type	PT100 Class B 4 wire
Range	0 to 80°C
Resolution	0.1 °C
Cable length	5m (standard)
Modbus	
Format	RTU
Baud rate	1200 to 38400
Standards	PI-MBUS-300 Rev. J
Physical connection	RS485
Enclosure	
Material	Plastic Polycarbonate
Fixing	Pipe mountable
Degree of Protection	IP54
Flammability Rating	UL94 V-0
Dimensions	250mm x 48mm x 90mm (electronics + guide rail)
Weight	0.5kg

Environmental	
Pipe temperature	0°C to 85°C
Operating temperature (Electronics)	0°C to 50°C
Storage temperature	-10°C to 60°C
Humidity	90% RH at 50°C Max
Display	
LCD	2 line x 16 characters
Viewing angle	Min 30°, Max 40°
Active area	83mm (W) x 18.6mm(H)
Keypad	
Format	4 key tactile feedback membrane keypad

12 Appendix II – Default values

The settings will be configured at the factory for either metric or imperial units. Table 2 lists the metric default values.

Table 2 System Default Values

Parameter	Default Value
Dimensions	mm
Flow Rate	l/min
Pipe size	50 (mm)
Pulse Output	On
Energy per Pulse	1kWh
Pulse Width	25ms
Damping	20 seconds
Calibration Factor	1.000
Zero Cut-off	0.10m/s
Zero Offset	0.000l/min
Modbus address	1
Baud rate	38400

Table 3 lists the default values when Imperial dimensions are selected.

Table 3 System Default Values

Parameter	Default Value
Dimensions	inches
Flow Rate	USgal/min
Pipe size	2 (inches)
Pulse Output	On
Energy per Pulse	1kWh
Pulse Width	25ms
Damping	20 seconds
Calibration Factor	1.000
Zero Cut-off	0.10m/s
Zero Offset	0.000gal/min
Modbus address	1
Baud rate	38400

13 Appendix III – Error and Warning Messages

System errors

There are three possible 'System Error' messages that can be displayed. These are:

1. **Poor Signal.** The unit is unable to detect a signal from one or both transducers. If this message persists the sensors will need to be relocated.
2. **Pulse Overflow.** The value for the 'Vol per pulse' is set too low. Increase the Vol per Pulse setting in the password-controlled menu.
3. **No BBME:** This indicates a unit failure. Reset the unit by turning the power on and off. Contact your supplier if the problem persists.

Flow and temperature errors

If the flow reading is lost or goes negative then the Flow Reading screen will be displayed to indicate the nature of the fault. A signal strength of less than 40% indicates poor set up of the instrument, and the installation should be checked or possibly moved to a different site. A negative flow is indicated by an "!" being displayed on the top line instead of a "**".

If the temperature difference exceeds the upper limit or the reading from either of the sensors is lost, then the Temperature Values screen will be displayed.

Warnings

These generally advise the user that the data entered is out of the specified range.

1. When an invalid Pipe ID is entered, the warning message shown below is displayed, prompting the user to enter a value between 20 and 110mm.

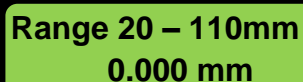

Range 20 – 110mm
0.000 mm

2. When programming a Frequency Pulse output the frequency is limited to the range 1 to 200 Hz. If an invalid value is entered then the following warning message is displayed.



Range 1 - 200
200

3. When programming a Volume Pulse output the pulse width is limited to the range 3 to 99ms. If an invalid value is entered then the following warning message is displayed.

Range 3 - 99
0000.0

4. When programming the Zero Cut-off this is limited to the range 0.000 to 0.500. If an invalid value is entered then the following warning message is displayed.

Range 0.00 – 0.500
0000.0

5. When programming the Calibration Factor this is limited to the range 0.5 to 1.5. If an invalid value is entered then the following warning message is displayed.

Range 0.500 – 1.500
0000.0

6. If an attempt is made to zero the offset between the temperature sensors, and the difference in temperature is too large then this error message will be displayed.

Calibrate Error
Press Enter

Ensure the temperature sensors are correctly plugged in and are both at the same temperature.



CE Declaration of Conformity

Micronics Ltd

Knaves Beech Business Centre
Davies Way, Loudwater,
High Wycombe, Bucks.
HP10 9QR

The Products Covered by this Declaration Ultrasonic flow meter U1000

This product is manufactured in accordance with the following Directives and Standards.

Directive 2004/108/EC of the European Parliament and of the Council of 15 December 2004 on the approximation of the laws of the Member States relating to electromagnetic compatibility

Directive 2006/95/EC of the European Parliament and of the Council of 12 December 2006 on the harmonisation of the laws of Member States relating to electrical equipment designed for use within certain voltage limits

The Basis on which Conformity is being Declared

The manufacturer hereby declares under his sole responsibility that the products identified above comply with the protection requirements of the EMC directive and with the principal elements of the safety objectives of the Low Voltage Equipment directive, and that the following standards have been applied:

BS EN 61010-1:2001 Safety requirement for electrical equipment for measurement control and laboratory use. Part 1 General requirements

BS EN61326-1:2006 Electrical equipment for measurement control and laboratory use EMC requirements. Part 1: General requirements

BS EN61326-2-3:2006 Electrical equipment for measurement control and laboratory use EMC requirements. Part 2-3: Particular requirements – Test configuration and performance criteria for transducers with integrated or remote signal conditioning.

The technical documentation required to demonstrate that the products meet the requirements of the Low Voltage Equipment directive has been compiled and is available for inspection by the relevant enforcement authorities. The CE mark was first applied in: 2012

Signature:

Printed Name:

Michael Farnon

Title:

Managing Director

Date:

2nd August 2012

Attention!

The attention of the specifier, purchaser, installer, or user is drawn to special measures and limitations to use which must be observed when these products are taken into service to maintain compliance with the above directives.

Details of these special measures and limitations to use are available on request, and are also contained in the product manuals.

Registered Office: Micronics Limited, Knaves Beech Business Centre, Davies Way, Loudwater, Buckinghamshire, HP10 9QR

Web site www.micronicsflowmeters.com Tel: +44 (1628) 810456 Fax: +44 (1628) 531540

Directors E.J. Farnon, M.A. Farnon

Registration No. 1289680 V.A.T Registration No. 303 6190 91